



Istruzioni per l'installazione

IT

Installation instructions

EN

Instrucciones para la instalación

ES

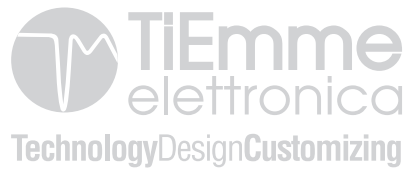

<b>ARCHITETTURA DEL SISTEMA</b>	<b>4</b>
<b>CONNESSIONE LOCALE E CONNESSIONE REMOTA</b>	<b>5</b>
<b>SPECIFICHE MECCANICHE</b>	<b>6</b>
<b>POSIZIONAMENTO TASTI E LED</b>	<b>7</b>
<b>INSTALLAZIONE</b>	<b>8</b>
<b>CONFIGURAZIONE NUOVO 4HEATModule</b>	<b>9</b>
<b>CONNESSIONE AD UN 4HEATModule GIÀ CONFIGURATO</b>	<b>12</b>
<b>HOME PAGE</b>	<b>14</b>
<b>SETTING 4HEAT</b>	<b>16</b>
<b>GESTIONE 4HEAT</b>	<b>17</b>
<b>FUNZIONALITÀ CRONO E 24HEATING</b>	<b>18</b>
<b>VISUALIZZAZIONE GRAFICI</b>	<b>23</b>
<b>SCHERMATA INFO</b>	<b>24</b>
<b>SCHERMATA MENU</b>	<b>25</b>

L'architettura prevede la presenza di 3 macro-sistemi:

1. **4HEATmodule:** dispositivo hardware che interfaccia la scheda di controllo TiEmme elettronica e il router Wi-Fi locale;
2. **SERVER CLOUD:** infrastruttura web server che permette l'archiviazione dati e funge da centro stella nella comunicazione remota;
3. **4HEAT:** applicazione per smartphone disponibile da Google Play Store e da App Store in modo gratuito, che permette all'utente di interfacciarsi con il sistema di riscaldamento

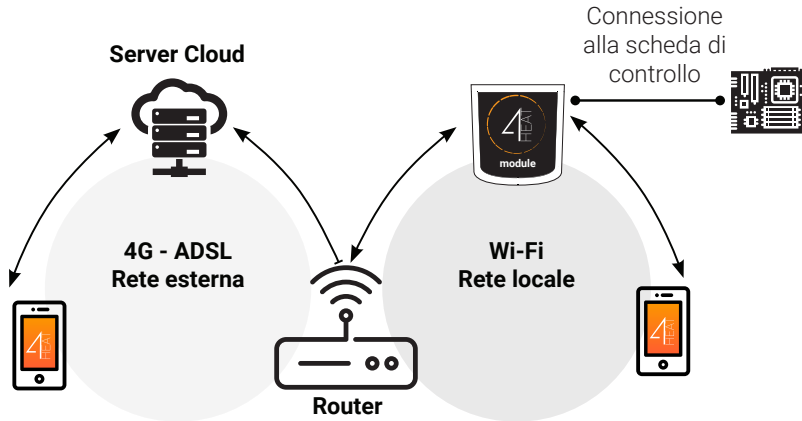

## 4HEAT • CONNESSIONE LOCALE E CONNESSIONE REMOTA

### Connessione Locale

La connessione tra il 4HEATModule e l'APP avviene attraverso la rete Wi-Fi domestica, soltanto se entrambi sono connessi alla stessa rete Wi-Fi.



### Connessione Remota

Si parla di connessione remota quando al momento dell'utilizzo della App, l'utente si trova lontano da casa. In questo caso l'App usufruisce della copertura dati del proprio Smartphone e il Server Cloud permette la triangolazione del segnale per poter gestire il Module da lontano. I tempi di connessione remota possono variare in base al traffico rete dati, alle condizioni di connessione della rete e al traffico verso il server. Nel peggiore dei casi, i tempi di connessione possono raggiungere i 5 minuti di ritardo.

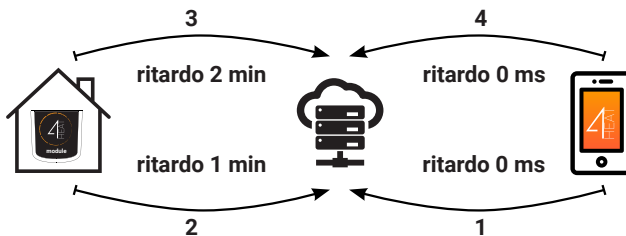

La modalità di connessione remota è utilizzabile solo se l'utente ha effettuato precedentemente la registrazione al Server Cloud, vedi paragrafo: "CONFIGURAZIONE NUOVO 4HEATModule" a pagina 10

IT

Porte di comunicazione	<b>RS232 RS485</b>
Alimentazione	<b>5V</b>
Involucro	<b>Housing in ABS</b>
Range di temperatura	<b>-20° ÷ 60°</b>
Fissaggio	<b>Viti autofilettanti da 3,5 mm</b>

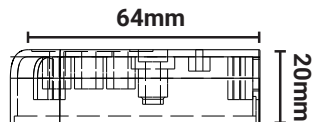
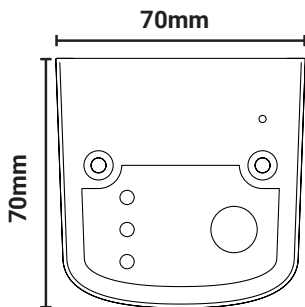

IT



*TiEmme elettronica garantisce il funzionamento del dispositivo solo con i cavi forniti in dotazione.*

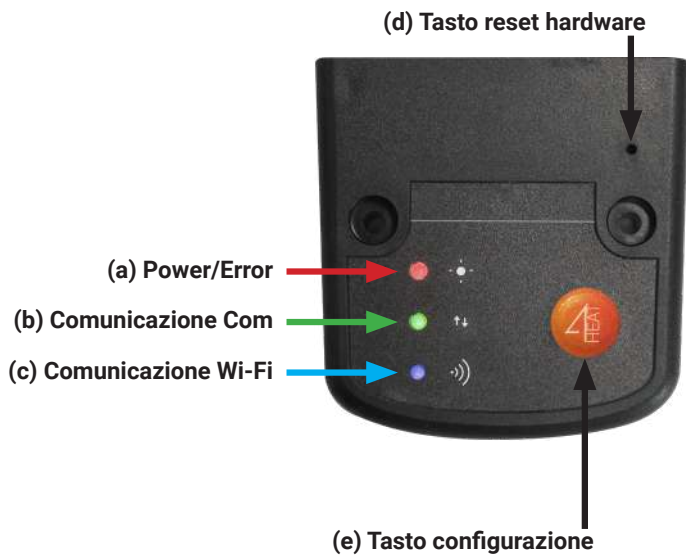

1. **Collegare il 4HEATModule all'alimentatore:** il Led (a) deve essere acceso e non lampeggiante;
2. **Collegare il 4HEATModule alla scheda TiEmme tramite il cavo fornito nel kit:** il led (b) deve essere acceso e non lampeggiante, nel caso di lampeggiamento possono esserci dei problemi di comunicazione con la scheda di controllo, accertarsi che il sistema di riscaldamento sia collegato a rete elettrica;
3. **Comunicazione Wi-Fi:** con led (c) fisso la connessione con l'APP 4HEAT ha avuto successo e il dispositivo sta comunicando correttamente;
4. **Tasto di reset hardware (d):** premere in caso di malfunzionamento persistente del prodotto.

<b>Power</b>	lampeggiante	stato errore
	fisso	stato OK
<b>COM</b>	lampeggiante	comunicazione della scheda di controllo non avvenuta
	fisso	comunicazione avvenuta
<b>Wi-Fi</b>	lampeggiante	connessione Wi-Fi non configurata
	fisso	Wi-Fi connesso
<b>POWER/ Wi-Fi</b>	lampeggiante	fase di configurazione



*Se il dispositivo risulta offline durante il normale funzionamento premere il tasto 4HEAT per 3 secondi il tasto.*

*Durante la configurazione e il funzionamento i Led possono passare da luce fissa a lampeggiante.*





## • CONFIGURAZIONE NUOVO 4HEATModule

Si consiglia di collegare fin da subito il proprio Smartphone alla rete Wi-Fi domestica. All'avvio dell' APP viene richiesta di selezionare la lingua.

Di seguito viene spiegata la procedura di configurazione del dispositivo 4HEATmodule:

1. Creare un account con un indirizzo email valido e una password a scelta.
2. Scegliere tra "AGGIUNGI DISPOSITIVO" e "TROVA DISPOSITIVO". Nel caso di prima accensione del 4HEATModule si deve selezionare "AGGIUNGI DISPOSITIVO".



## 4HEAT • CONFIGURAZIONE NUOVO 4HEATModule

3. Seguire la procedura guidata. Il 4HEATModule crea una Wi-Fi provvisoria alla quale ci si deve collegare con lo Smartphone. In questo modo il Module sarà connesso all'app e all'account associato;
4. Una volta che l'app e il 4HEATModule sono connessi si richiede in questa fase di scegliere la Wi-Fi domestica a cui deve connettersi il dispositivo 4HEATModule;
5. Scrivere un nome per il dispositivo e inserire un PIN a scelta. Ogni dispositivo 4HEATModule ha un nome e una password propri.



IT



*Se la procedura di configurazione non è andata a buon fine, si può riconfigurare il 4HEATModule tenendo premuto per 8 secondi il tasto *

## 4HEAT • CONFIGURAZIONE NUOVO 4HEATModule

Terminata la procedura di installazione del dispositivo 4HEATModule, si consiglia di chiudere la app e di riavviarla.



Chiudere la app tra le finestre aperte in background.

### **Su dispositivi Apple**

- Tocca due volte il tasto Home
- Scorri verso l'alto l'anteprima dell'app 4HEAT per chiuderla.

### **Su dispositivi Android**

- Premere il tasto in basso a destra per dispositivi con tasti virtuali o il tasto in basso a sinistra per dispositivi con tasti fisici
- Scorri verso sinistra l'anteprima dell'app 4HEAT per chiuderla.



## 4HEAT • CONNESSIONE AD UN 4HEATModule GIÀ CONFIGURATO

Nella sezione “TROVA DISPOSITIVO” è possibile connettersi al 4HEATModule inserendo il codice PIN, solo se il 4HEATModule è connesso alla stessa Wi-Fi dello smartphone.

E' possibile inoltre connettersi da remoto (utilizzando la connessione dati del proprio smartphone) inserendo le credenziali di accesso del dispositivo 4HEATModule già configurato.

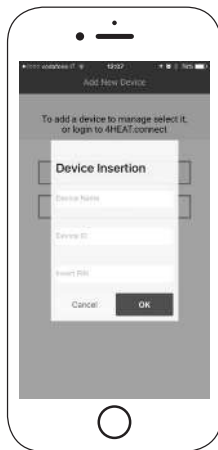

## 4HEAT • CONNESSIONE AD UN 4HEATModule GIÀ CONFIGURATO

Nella Home Page viene visualizzato l'elenco dei dispositivi collegati e per ognuno viene mostrata la temperatura principale e lo stato.

I dispositivi 4HEAT associati appaiono nella schermata Home con il loro nome identificativo.

Viene segnalato:

- ❌ Stato di funzionamento SPENTO
- ⚠️ Stato di funzionamento BLOCCO
- ✅ Stato di funzionamento ACCESO
- 📶 Dispositivo non collegato o irraggiungibile
- 🔄 Aggiornamento necessario

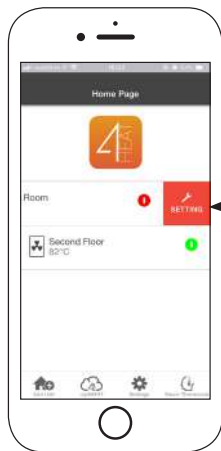

Accesso alle impostazioni del dispositivo 4HEATModule associato. "SETTING 4HEAT" a pagina 16



Add Unit

Questo menu permette di configurare un altro dispositivo 4HEATModule.  
"CONFIGURAZIONE NUOVO 4HEATModule" a pagina 9



my4HEAT

Nel menu **my4HEAT** vengono elencate le credenziali dei dispositivi associati alla propria app.

Attraverso il tasto  è possibile inviare, tramite servizi di e-mail e messaggistica, i dati alle applicazioni 4HEAT di altri utenti, permettendo la condivisione della gestione del Sistema di Riscaldamento.



Settings

- Gestione Account: menu che permette di creare un nuovo account o di effettuare il Login/Logout.
- Ripristina App: permette di resettare la APP alle condizioni di Default
- Riabilita Tutorial: permette di riabilitare il tutorial di guida alla app.
- Gestione Notifiche: permette di abilitare le notifiche dello stato del sistema di riscaldamento.
- Lingua: permette di impostare la lingua
- Info App: permette di visualizzare le informazioni relative alla versione della APP installata sul proprio smartphone
- Download Manuale: permette di scaricare il manuale utente di spiegazione all'utilizzo della APP. Premere l'icona di salvataggio per memorizzare il manuale nella memoria interna dello smartphone.

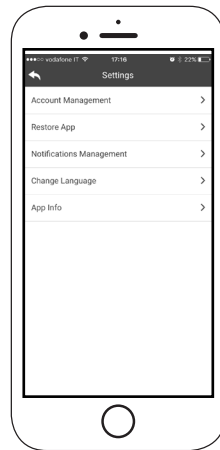

## 4 • HOME PAGE



Permette di collegarsi alle applicazioni di gestione dei termostati intelligenti installati nel proprio sistema domestico. Per collegarsi al termostato intelligente inserire le credenziali di account registrate durante la configurazione dello stesso.

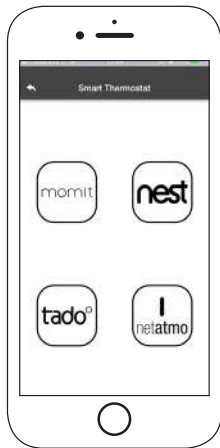

Accesso al menu di impostazioni riguardante il 4HEAT Module selezionato.

- **Nome Dispositivo:** è possibile cambiare il nome del dispositivo corrente;
- **Icona Dispositivo:** modifica l'icona di visualizzazione dell'unità nella home page;
- **Abilitazione Assistenza Remota:** l'utente abilita la possibilità di ricevere assistenza tecnica in remoto;
- **Widget:** permette di selezionare i Widget che appaiono nella schermata principale di gestione del dispositivo;
- **Impostazioni Menu:** permette di personalizzare la visualizzazione delle funzioni di menu. Alcune funzioni possono non essere disponibili a causa della configurazione del sistema di riscaldamento. Vedi "SCHERMATA MENU" a pagina 25;
- **Impostazioni Info:** permette di personalizzare la visualizzazione delle grandezze di sistema del menu info. Vedi "SCHERMATA INFO" a pagina 24;
- **Elimina Dispositivo:** permette di eliminare il dispositivo attualmente selezionato;
- **Modifica Meteo:** il meteo locale, che appare come widget, può essere impostato manualmente inserendo le coordinate di latitudine e longitudine desiderate, oppure utilizzando il GPS del proprio Smartphone;
- **Info:** informazioni tecniche relative al codice prodotto della scheda di controllo e alla versione firmware del Module;
- **Info Wi-Fi:** informazioni relative alla rete internet alla quale il dispositivo 4HEATModule è connesso.

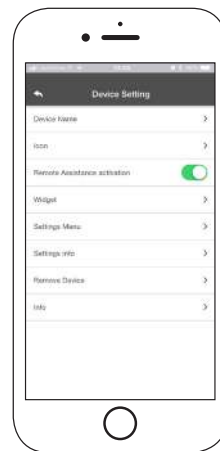





**Stato Funzionamento:**

mostra lo stato in cui si trova il sistema ed eventuali errori

**Termostato Principale:**

visualizza il termostato del sistema.

Tenendo premuto il tasto  si abilita la modifica del termostato.

Con i tasti  e  oppure scorrendo con il dito sulla banda a colori si varia la temperatura.

**Widget:**

visualizzano le informazioni relative al funzionamento. Si può decidere quali widget mostrare nella schermata principale attraverso il menù .

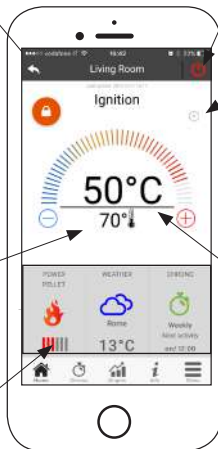

 **Sistema ACCESO:**  
premere per spegnerlo

 **Sistema SPENTO:**  
premere per accenderlo

**Sincronizzazione:**

 lampeggiante indica che l'applicazione e il modulo si stanno scambiando informazioni. Al termine viene dato riscontro dell'esito della modifica.

**Temperatura Principale**

## 🕒 • FUNZIONALITÀ CRONO E 24HEATING

Accedendo al menu Crono si può impostare la funzione di gestione del sistema, in due differenti modalità.

Premendo su  si accede alla modifica della funzione desiderata.



Entrando nella funzione **CRONO** si possono impostare 3 differenti fasce orarie per l'accensione e lo spegnimento del sistema di riscaldamento.

Si possono scegliere tre tipi di programmazione:

- **Settimanale:** Impostazione dal Lunedì alla Domenica
- **Giornaliero:** Impostazione di ogni singolo giorno
- **Weekend:** Impostazione durante il weekend (sabato e domenica) oppure durante i giorni feriali (dal lunedì al venerdì).

Ogni volta che questa funzione viene aggiornata è necessario premere il tasto di Salvataggio che compare a fondo schermata. Per resettare la fascia oraria utilizzare il cestino che appare con lo slide-touch a destra della fascia oraria.

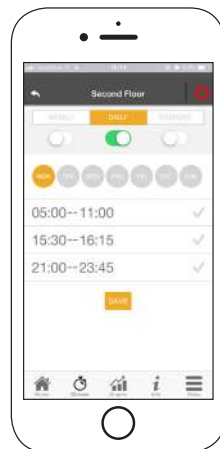

## • FUNZIONALITÀ CRONO E 24HEATING

La funzione **24HEATING** permette, attraverso una procedura guidata, di poter gestire il riscaldamento domestico, andando ad impostare orari e temperature, in base alle esigenze quotidiane.



Durante la procedura guidata vengono poste poche semplici domande di routine quotidiana, attraverso le quali il 24Heating imposta la programmazione settimanale. Viene data la possibilità di scegliere il termostato per le tre fasce disponibili



**24HEATING** permette di gestire le fasce orarie anche dalla schermata principale:



## 🕒 • FUNZIONALITÀ CRONO E 24HEATING

1. **Gestione programmi 24HEATING:** il menu a tendina in alto a sinistra mostra i programmi impostati dall'utente. Selezionare la nuvoletta per abilitare il programma. Premere sul simbolo  per modificare i termostati di ogni fascia
2. **Aggiungi fascia oraria:** selezionando il pulsante  si può sdoppiare una fascia oraria, come viene mostrato dalle immagini:



Premendo sul simbolo "+" , si divide la fascia in due, mantenendo le stesse impostazioni della fascia di partenza

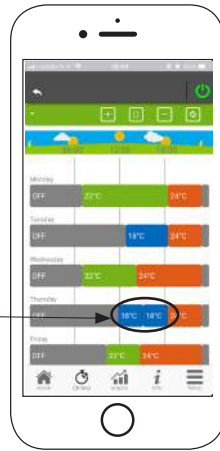



## 🕒 • FUNZIONALITÀ CRONO E 24HEATING

3. **Eliminazione fascia oraria:** selezionando il pulsante  si può eliminare una fascia oraria, come mostrato dalle immagini:

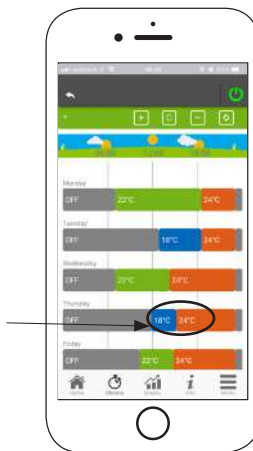

Premendo sul simbolo "-", si elimina la fascia oraria desiderata



4. **Aggiornamento modifiche:** attraverso il pulsante  si sincronizza il 24Heating con il dispositivo. Accertarsi di premerlo ogni volta che viene effettuata una modifica.

## 🕒 • FUNZIONALITÀ CRONO E 24HEATING

- Copia di una fascia oraria:** Selezionando il pulsante  posso copiare le fasce orarie da un giorno all'altro. Al termine premere il tasto di conferma in fondo alla pagina.
- Modifica della fascia oraria:** Premendo su una fascia oraria si accede al menu di gestione, come indicato dall'immagine:

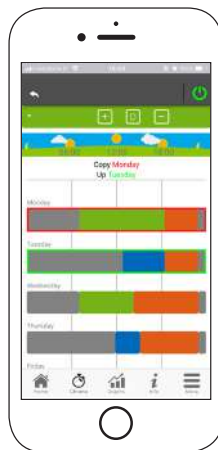

## • VISUALIZZAZIONE GRAFICI

In questa sezione vengono visualizzati i grafici delle grandezze loggate sul server dal 4HEATModule. Sono disponibili due tipi di visualizzazioni:

1. **Giornaliera:** le grandezze visualizzate sono rappresentate nell'arco della giornata di funzionamento del sistema di riscaldamento. Si possono visualizzare i grafici di due fasce orarie: 00:00/12:00 o 12:00/00:00. Si può scegliere inoltre di visualizzare anche gli stati di funzionamento del sistema di riscaldamento (es. Spento/Normale/Blocco etc.). I dati registrati restano in memoria con cadenza settimanale;
2. **Periodo:** rappresentazione grafica su base settimanale delle ore di funzionamento del sistema. I dati registrati restano in memoria con cadenza annuale.



In questa schermata vengono visualizzate tutte le grandezze registrate dalla scheda di controllo. Le grandezze da visualizzare possono essere impostate attraverso il Setting Menu del dispositivo 4HEATModule selezionato. "SETTING 4HEAT" a pagina 16



**i** È inoltre possibile visualizzare i dati di riferimento del fornitore del servizio e inviare eventuali richieste di assistenza tramite mail. Qualora la App sia personalizzata per uno specifico cliente, è possibile introdurre gli eventuali dati d'identificazione.



## 4 • SCHEMATA MENU

Nella schermata Menu è possibile accedere a:

- **Gestione Potenza:** in questo menu è possibile modificare la potenza di combustione e/o l'eventuale potenza di riscaldamento;
- **Gestione Termostato:** permette di modificare il termostato principale ed altri eventuali termostati qualora previsto dalle funzionalità del Sistema di Riscaldamento.



IT

<b>SYSTEM STRUCTURE</b>	<b>2</b>
<b>LOCAL CONNECTION AND REMOTE CONNECTION</b>	<b>3</b>
<b>MECHANICAL SPECIFICATIONS</b>	<b>4</b>
<b>BUTTONS AND LED</b>	<b>5</b>
<b>INSTALLATION</b>	<b>6</b>
<b>NEW 4HEATModule CONFIGURATION</b>	<b>7</b>
<b>CONNECTION TO A 4HEATModule ALREADY CONFIGURED</b>	<b>10</b>
<b>HOME PAGE</b>	<b>11</b>
<b>SETTING 4HEAT</b>	<b>14</b>
<b>4HEAT MANAGEMENT</b>	<b>15</b>
<b>CHRONO AND 24HEATING FUNCTION</b>	<b>16</b>
<b>GRAPH VIEW</b>	<b>21</b>
<b>INFORMATION PAGE</b>	<b>22</b>
<b>MENU PAGE</b>	<b>23</b>

## 4HEAT • SYSTEM STRUCTURE

The structure is comprised of 3 macro-systems:

1. **4HEATmodule:** hardware device that interfaces the TiEmme elettronica control board with the local Wi-Fi router;
2. **SERVER CLOUD:** web server infrastructure that enables data storage and acts as a star point for remote communication;
3. **4HEAT:** mobile application available from Google Play Store and App Store for free, which allows the user to interface with the heating system.

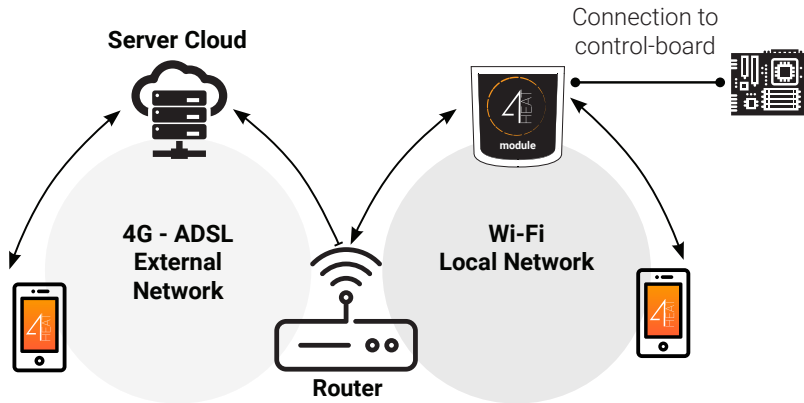

## 4HEAT • LOCAL CONNECTION AND REMOTE CONNECTION

### Local connection

The connection between the 4HEATModule and the APP is via the home Wi-Fi network, only if both are connected to the same Wi-Fi network.



### Remote connection

There is talk of remote connection when at the time of use of the App, the user is away from home. In this case the App takes advantage of the data coverage of your Smartphone and the Cloud Server allows the triangulation of the signal in order to manage the Module from a distance. Remote connection times may vary based on data network traffic, network connection conditions, and traffic to the server. In the worst case, connection times may be 5 minutes late.

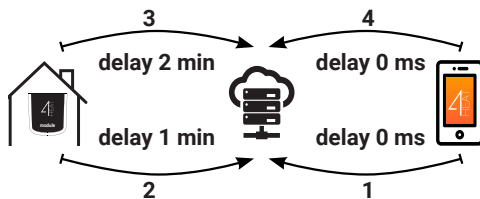

## • MECHANICAL SPECIFICATIONS

Communication ports	<b>RS232 RS485</b>
Power supply	<b>5V</b>
Housing	<b>Housing in ABS</b>
Temperature range	<b>-20° ÷ 60°</b>
Fixing	<b>self-tapping screws 5 mm</b>

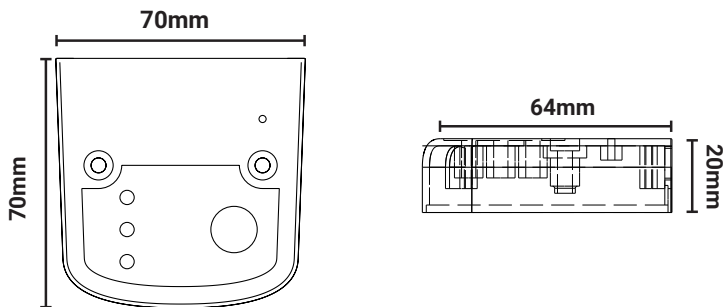

*TiEmme elettronica garantisce il corretto funzionamento del dispositivo e dei cavi forniti.*

EN

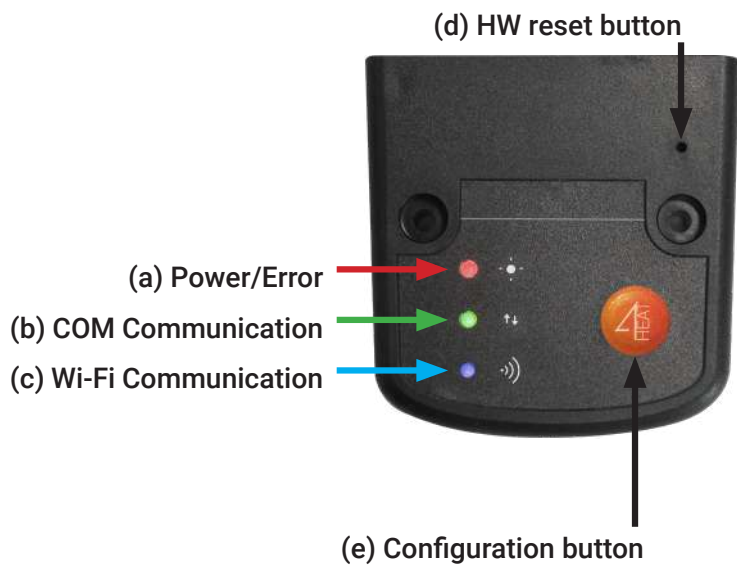

## 4HEAT • INSTALLATION

1. **Connect the 4HEATModule to the power supply:** the LED (a) must be on and not flashing;
2. **Connect the 4HEATModule to the TiEmme board using the cable supplied in the kit:** the LED (b) must be on and not flashing, in case of flashing there may be problems communicating with the control board, make sure that the heating system is connected to the mains power supply;
3. **Wi-Fi communication:** with LED (c) solid the connection with the APP 4HEAT has been successful and the device is communicating correctly;
4. **Hardware reset button (d):** press in case of persistent product malfunction.

<b>Power</b>	flashing	error
	solid	OK
<b>COM</b>	flashing	not communicating with the control board
	solid	Communication present
<b>Wi-Fi</b>	flashing	Wi-Fi is not configured
	solid	Wi-Fi connected
<b>POWER/ Wi-Fi</b>	flashing	Configuration phase



*If the device is offline during normal operation, press the 4HEAT button for 3 seconds. During configuration and operation, the LEDs can change from solid to flashing light.*

It is recommend to connect your Smartphone to the home Wi-Fi before starting the procedure. At the start, a language must be selected.

The configuration procedure is explained below:

1. Create an account with a valid email address and a password of your choice.
2. Choose between "ADD DEVICE" and "FIND DEVICE". If the 4HEAT Module is switched on for the first time, "ADD DEVICE" must be selected.







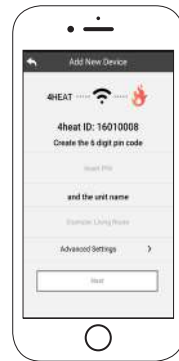

## • NEW 4HEATModule CONFIGURATION

3. Follow the procedure. The 4HEATModule creates a temporary Wi-Fi to which you must connect with the Smartphone. In this way the Module will be connected to the app and the associated account;
4. Once the app and the 4HEATModule are connected, it is required to choose the home Wi-Fi to which the 4HEATModule device must connect;
5. Write a name for the device and enter a PIN of your choice. Each 4HEATModule device has its own name and password.



*If the configuration procedure was not successful, the 4HEATModule can be reconfigured by pressing the  button for 8 seconds*

After completing the installation procedure of the 4HEATModule, it is advisable to close the app and restart it.



Close the app between open windows in the background.

#### **On Apple device**

- Touch the Home button twice
- Scroll up the preview of the 4Heat app to close it.

#### **On android devices**

- Press the lower right button for virtual buttons or the lower left button for devices with real buttons
- Scroll to the left to close the 4HEAT app preview.





## • CONNECTION TO A 4HEATModule ALREADY CONFIGURED

In the "FIND DEVICE" section, it is possible to connect to the 4HEATModule by entering the PIN code, only if the 4HEATModule is connected to the same Wi-Fi as the smartphone.

It is also possible to connect remotely (using the data connection of your smartphone) by entering the access credentials of the already configured 4HEATModule device.

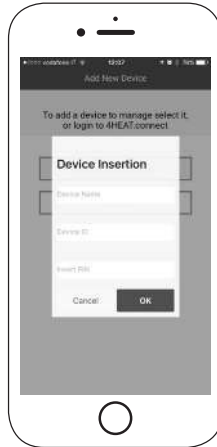

The Home Page displays the 4HEATModule including the temperature and functioning state.

The associated 4HEAT devices appear on the Home Page with their identification name.

In the following manner:

- ❶ Operating status OFF
- ❷ Operating status BLOCK
- ❸ Operating status ON
- ❹ Device not connected or unreachable
- 🔄 Updating required



Access to the settings of the associated 4HEAT Module device. "SETTING 4HEAT" at page 14



Add Unit

This menu is used you to configure another 4HEATModule device.  
See page 13.



In MY 4HEAT is shown the device credentials associated with your app.  
Using the button  it is possible to send, via e-mail and messaging services, the data to the 4HEAT applications of other users, in order to share the Heating System management.



Settings

- **Account Management:** menu that allows you to create a new account or log in / out;
- **Restore App:** allows you to reset the app to the default conditions;
- **Re-enableTutorial:** allows you to re-enable the app tutorial tutorial;
- **Notifications Management:** allows you to enable notifications of the heating system status;
- **Change Language:** allows you to set the app language;
- **Info App:** allows you to view information about the version of the installed app on your smartphone;
- **Download Istruction:** allows you to download the user manual of the app. Press the save icon to store the manual in the internal memory of the smartphone.

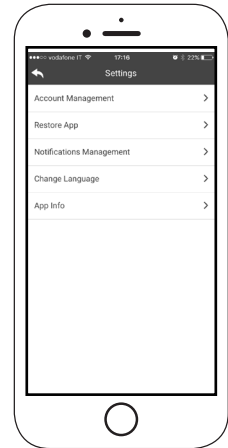



It allows you to connect to the following smart thermostats installed in your home by entering the credentials of registered accounts during the configuration of the same.

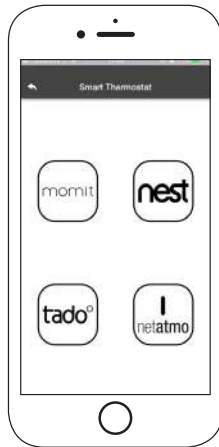



## 4HEAT • SETTING 4HEAT

Access to the settings menu of the selected 4HEAT Module.

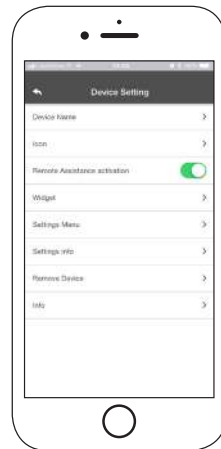

- **Device Name:** use to change the name of the current device;
- **Icon:** change the unit display icon on the home page;
- **Remote Assistance Activation:** the user enables the possibility to receive remote technical assistance;
- **Widget:** allows you to select the Widgets that appear on the main device management screen;
- **Settings menu:** allows you to customize the display of menu functions. Some features may not be available due to the configuration of the heating system. "MENU PAGE" at page 23
- **Settings Info:** allows you to customize the display of the system values of the info menu. "INFORMATION PAGE" at page 22
- **Remove Device:** allows to delete the currently selected device;
- **Weather Modification:** the local weather, which appears as a widget, can be set manually by entering the desired latitude and longitude coordinates, or using the GPS of your Smartphone;
- **Info:** technical information concerning the product code of the control board and the firmware version of the Module;
- **Wi-Fi Info:** information about the internet network to which the 4HEATModule device is connected.



**Operation Status:**  
shows the state in which the system is functioning and any errors

**Main Thermostat:**  
displays the system thermostat. By keeping the key  pressed you enable the thermostat changes. Use the  and  buttons or scroll through the color band to change the temperature.

**Widget:**  
displays information related to the system. You can decide which widget to show on the home page through the menu .

 **System ON:** push to turn it off  
 **System OFF:** push to turn it on

**Synchronization:**  
 the flashing button indicates that the application and the module are exchanging information. The synchronization result will be displayed in the end.

**Main Temperature**

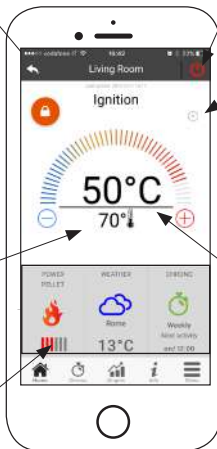



## • CHRONO AND 24HEATING FUNCTION

By accessing into the Chrono menu you can set the system management function in two different modes.

Pushing on  you can modify the selected modality.



Entering the **CHRONO** modality you can set 3 different time slots for switching the heating system on and off.

You can choose three types of programming:

- Weekly: Setting from Monday to Sunday
- Daily: Setting up every single day
- Weekend: Setting during the weekend (Saturday and Sunday) or during the weekdays (from Monday to Friday).

Each time this function is updated, press the Save button that appears at the bottom of the screen.

To reset the time slot use the basket that appears with the slide-touch to the right of the time slot.

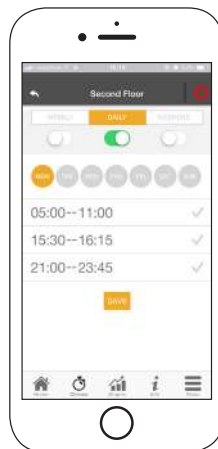

## 🕒 • CHRONO AND 24HEATING FUNCTION

The **24HEATING** function is a guided procedure to manage the domestic heating by setting the times and temperatures according to daily needs.

The wizard asks a few simple questions of the daily routine through which the 24Heating sets the weekly schedule.



It is possible to choose the thermostat for the three available time bands:

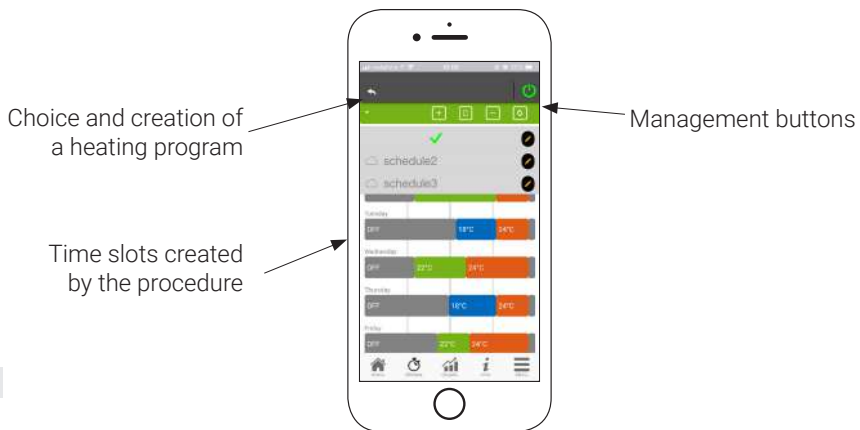

**24HEATING** allows you to manage time slots also from the main screen:



## 🕒 • CHRONO AND 24HEATING FUNCTION

1. **24HEATING program management:** The drop-down menu at the top of the page shows the programs set by the user. Select the speech bubble to enable the program. Press on the symbol  to change the thermostats of each band.
2. **Add time slot:** By selecting the button  you can split a time slot, as shown by the images:





By pressing the "+" symbol, it is possible to divide a slot in two, keeping the same settings of the starting slot.

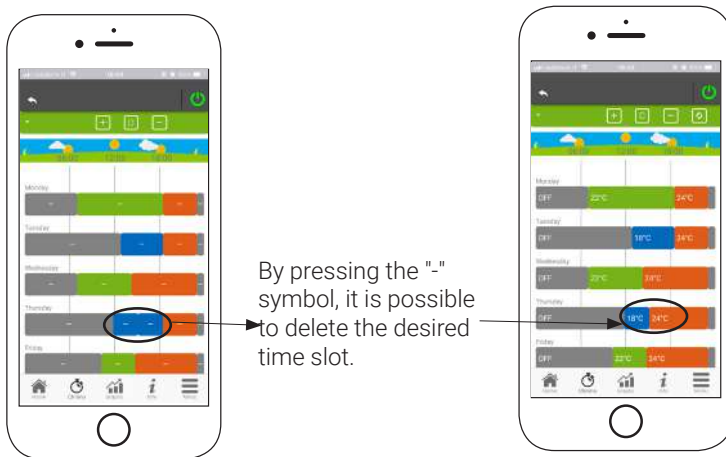

## 🕒 • CHRONO AND 24HEATING FUNCTION

- Elimination of time slot:** by selecting the button  you can delete a time slot, as shown in the pictures:



- Update changes:** Through the button  24Heating is synchronized with the device. Be sure to press it each time a change is made

## • CHRONO AND 24HEATING FUNCTION

- Copy of a time slot:** by selecting the button  you can copy the time slots from one day to the another. When finished, press the confirm button at the bottom of the page
- Change of time slot:** pressing on a time slot you access to the management menu, as indicated by the image:

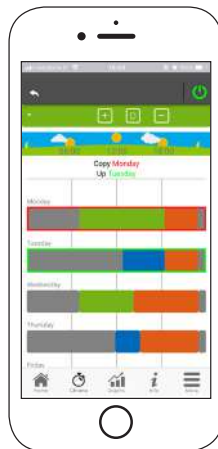

## • GRAPH VIEW

This section shows the graphs of the values logged on the server by the 4HEATModule. Two types of views are available:

1. **Daily:** the displayed values are represented during the daily of operation of the heating system. You can view the graphs of two time slots: 00: 00/12: 00 or 12: 00/00: 00. You can also choose to display the operating status of the heating system (ex. Off / Normal / Block etc.). The recorded data is saved for a week.
2. **Period:** it is a graphical representation of the system's operating hours based on a week. The recorded data is saved for a year.



## **i** • INFORMATION PAGE

This page displays all the quantities registered by the control board.  
The quantities to be displayed can be set through the Setting Menu of the selected 4HEAT Module. "SETTING 4HEAT" at page 14



*You can also view the service provider's reference data and send any support requests via email. If the App is customized for a specific customer, any identification data can be introduced.*

EN

## 4 • MENU PAGE

On the Menu Page, you can access:

- **Power management:** in this menu it is possible to modify the combustion power and / or the heating power;
- **Thermostat management:** allows you to change the main thermostat and other thermostats if required by the heating system functions.





<b>ARQUITECTURA DEL SISTEMA</b>	<b>2</b>
<b>CONEXIÓN LOCAL Y CONEXION REMOTA</b>	<b>3</b>
<b>CARACTERÍSTICAS MECÁNICAS</b>	<b>4</b>
<b>POSICIONAMIENTO TECLAS Y LEDS</b>	<b>5</b>
<b>INSTALACIÓN</b>	<b>6</b>
<b>NUEVA CONFIGURACIÓN DE 4HEATModule</b>	<b>7</b>
<b>CONEXIÓN A UN DISPOSITIVO 4HEATModule YA CONFIGURADO</b>	<b>10</b>
<b>HOME PAGE</b>	<b>11</b>
<b>SETTING 4HEAT</b>	<b>14</b>
<b>GESTIÓN 4HEAT</b>	<b>15</b>
<b>FUNCIÓN CHRONO Y 24HEATING</b>	<b>16</b>
<b>VISUALIZACIÓN DE GRÁFICOS</b>	<b>21</b>
<b>PANTALLA DE INFORMACIÓN</b>	<b>22</b>
<b>PANTALLA DE MENU</b>	<b>23</b>

La arquitectura incluye 3 macro-sistemas

1. **4HEATmodule:** dispositivo hardware que pone en comunicación la placa de control TiEmme elettronica con el router wifi local;
2. **SERVER CLOUD:** server web que permite el almacenamiento datos y hace de centro estrella en la comunicación remota;
3. **4HEAT:** aplicación de smartphone disponible en Google Play Store y App Store gratis, que permite al usuario interactuar con el sistema de calefacción.

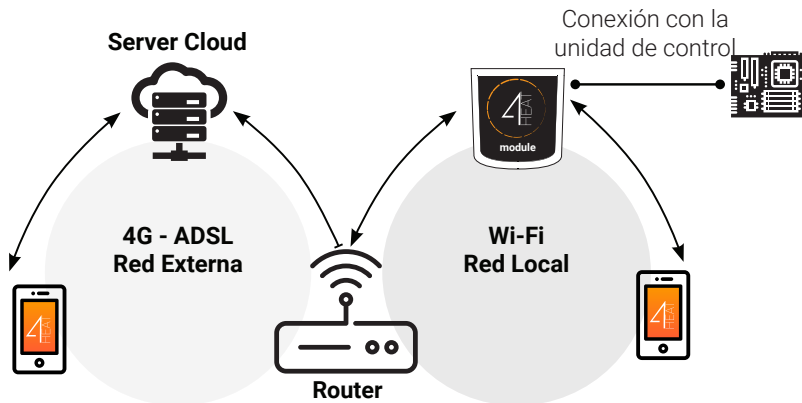

## 4HEAT • CONEXIÓN LOCAL Y CONEXIÓN REMOTA

### Conexión Local

La conexión entre el 4HEATModule y la APLICACIÓN se realiza a través de la red Wi-Fi doméstica, solo si ambas están conectadas a la misma red Wi-Fi.



### Conexión Remota

Se habla de conexión remota cuando, en el momento del uso de la aplicación, el usuario está fuera de casa. En este caso, la aplicación aprovecha la cobertura de datos de su Smartphone y el Cloud Service permite la triangulación de la señal para gestionar el módulo a distancia. Los tiempos de conexión remota pueden variar según el tráfico de red de datos, las condiciones de conexión de red y el tráfico al servidor. En el peor de los casos, los tiempos de conexión pueden llegar a tardar 5 minutos.

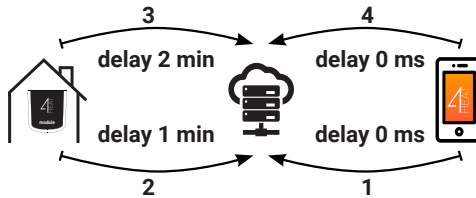

La conexión remota solo se puede utilizar si el usuario se ha registrado previamente en el Cloud Service; consulte el párrafo: "NUEVA CONFIGURACIÓN DE 4HEATModule" en la página 7.

## 4 • CARACTERÍSTICAS MECÁNICAS

Puertos de comunicación	<b>RS232 RS485</b>
Alimentación	<b>5V</b>
Alojamiento	<b>Housing in ABS</b>
Rango de temperatura	<b>-20° ÷ 60°</b>
Anclaje	<b>Tornillos taladradores de 3.5 mm</b>

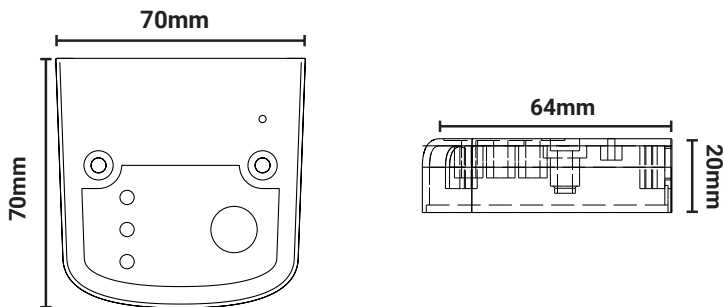

*TiEmme elettronica garantiza el funcionamiento del dispositivo sólo con los cables en dotación.*

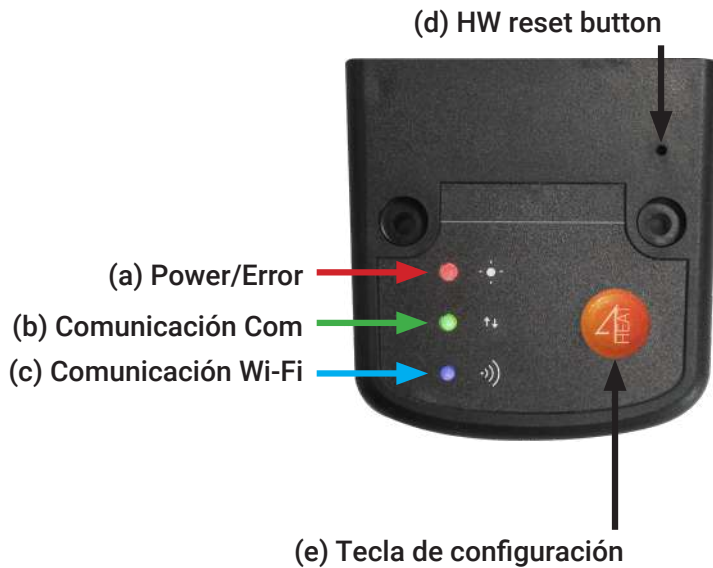

## 4HEAT • INSTALACIÓN

1. **Conecte el 4HEATModule a la fuente de alimentación:** el LED (a) debe estar encendido y no parpadeando;
2. **Conecte el 4HEATModule a la placa TiEmme usando el cable suministrado en el kit:** el LED (b) debe estar encendido y no parpadeando; en caso de parpadeo, pueden haber problemas de comunicación con la placa de control, asegúrese de que el sistema de calefacción esté conectado a la red eléctrica;
3. **Comunicación Wi-Fi:** con LED (c) fijo la conexión con la APLICACIÓN 4HEAT ha sido exitosa y el dispositivo se está comunicando correctamente;
4. **Botón de restablecimiento de hardware (d):** presione en caso de mal funcionamiento persistente del producto.

<b>Power</b>	parpadeo	error
	luz	OK
<b>COM</b>	parpadeo	Comunicación de la placa no realizada
	luz	Comunicación realizada
<b>Wi-Fi</b>	parpadeo	Conexión Wi-Fi no configurada
	luz	Wi-Fi conectado
<b>POWER/ Wi-Fi</b>	parpadeo	Fase de configuración



*Si el dispositivo está fuera de línea durante el funcionamiento normal, presione el botón 4HEAT durante 3 segundos. Durante la configuración y el funcionamiento, los LED pueden cambiar de luz fija a luz intermitente.*



## • NUEVA CONFIGURACIÓN DE 4HEATModule

Recomendamos conectar desde el principio su Smartphone a la red Wi-Fi del hogar. Cuando se inicie de la aplicación, se solicita seleccionar el idioma.

El procedimiento para configurar el 4HEATModule se explica a continuación:

1. Cree una cuenta con una dirección de correo electrónico válida y una contraseña de su elección.
2. Elija entre "AGREGAR DISPOSITIVO" y "ENCONTRAR DISPOSITIVO". Si el 4HEATModule se enciende por primera vez, se debe seleccionar "AGREGAR DISPOSITIVO".

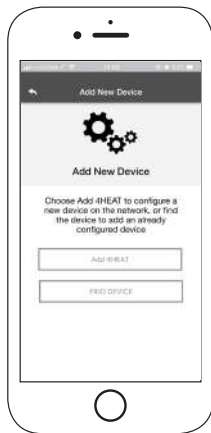

3. Siga el procedimiento guiado. El 4HEATModule crea un Wi-Fi temporal al que debe conectarse con el teléfono inteligente. De esta forma, el Módulo se conectará a la aplicación y a la cuenta asociada;
4. Una vez que la aplicación y el 4HEATModule están conectados, en esta etapa se requiere elegir el Wi-Fi doméstico al que debe conectarse el dispositivo 4HEATModule;
5. Escriba un nombre para el dispositivo e ingrese un PIN de su elección. Cada dispositivo 4HEATModule tiene su propio nombre y contraseña

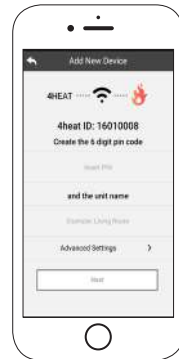

*Si el procedimiento de configuración no fue exitoso, el 4HEATModule puede reconfigurarse presionando el botón durante 8 segundos*





Después de completar el procedimiento de instalación del dispositivo 4HEATModule, es recomendable cerrar la aplicación y reiniciarla.



Cierre la aplicación entre las ventanas abiertas en el fondo.

### En dispositivos Apple

- Toque dos veces la tecla Home
- Desplace hacia arriba la anticipación del la APP 4HEAT para cerrarla.

### En dispositivos Android

- Pulse la tecla en la parte inferior derecha para los dispositivos con teclas virtuales o la tecla en la parte inferior izquierda para dispositivos con teclas físicas.
- Desplace hace la izquierda la anticipación del la APP 4HEAT para cerrarla.



## 4HEAT • CONEXIÓN A UN DISPOSITIVO 4HEATModule YA CONFIGURADO

En la sección "ENCONTRAR DISPOSITIVO", es posible conectarse al 4HEATModule introduciendo el código PIN, sólo si el 4HEATModule está conectado al mismo Wi-Fi que el Smartphone.

También es posible conectarse de forma remota (utilizando la conexión de datos de su Smartphone) ingresando las credenciales de acceso del dispositivo 4HEATModule ya configurado.

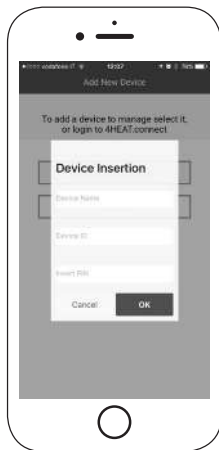

## 4HEAT • HOME PAGE

En la página de Inicio se muestra la lista de dispositivos conectados y la temperatura y el estado principal para cada uno.

Los dispositivos 4HEAT asociados aparecen en la página de inicio con su nombre de identificación.

Se informa:

- ❶ Estado de funcionamiento OFF
- ❷ Estado de funcionamiento BLOQUEO
- ❸ Estado de funcionamiento ENCENDIDO
- ❹ Dispositivo no conectado o inalcanzable
- 🔄 Actualización requerida

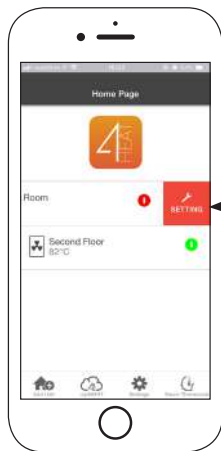

Acceso a la configuración del dispositivo del 4HEATModule asociado.

"SETTING 4HEAT" en la página 14



Add Unit

Este menú le permite configurar otro dispositivo 4HEATModule. Ver el procedimiento descrito a pag. 13.



En el menú MY 4HEAT se enumeran las credenciales de los dispositivos asociados a su aplicación

Con la tecla  es posible enviar, a través de e-mail y servicios de mensajería, los datos a las aplicaciones 4HEAT de otros usuarios, lo que permite compartir la gestión del sistema de calefacción.



Settings

- **Gestión Cuenta:** menú que le permite crear una nueva cuenta o iniciar sesión / salir.
- **Restaurar App:** le permite restablecer la aplicación a las condiciones predeterminadas
- **Vuelva a habilitar el tutorial:** le permite volver a habilitar el tutorial de la aplicación.
- **Gestión Notificaciones:** permite activar las notificaciones sobre el estado del sistema de calefacción.
- **Cambio de Idioma:** le permite configurar el idioma
- **Info App:** le permite ver información sobre la versión de la aplicación instalada en su Smartphone.
- **Descarga Instrucciones:** permite descargar el manual del usuario explicando el uso de la APLICACIÓN. Presione el icono guardar para almacenar el manual en la memoria interna del teléfono inteligente.

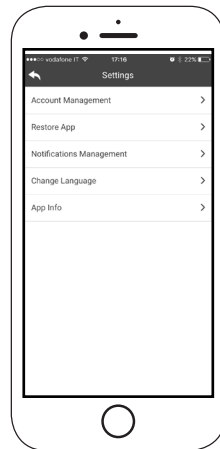

## 4 • HOME PAGE



Le permite conectarse a las aplicaciones de administración de termostatos inteligentes instalados en su sistema doméstico. Para conectarse al termostato inteligente ingrese la cuenta que se hayan registrado durante la configuración del mismo

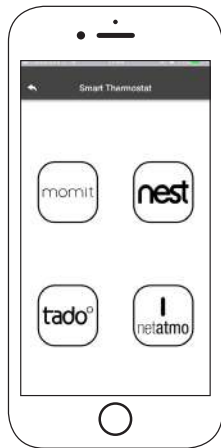

Acceda al menú de configuración para el Módulo 4HEAT seleccionado.

- **Nombre Dispositivo:** es posible cambiar el nombre del dispositivo actual;
- **Icono:** modifica el icono de visualización de la unidad en la página de inicio;
- **Habilitación Asistencia Remota:** el usuario habilita la posibilidad de recibir asistencia técnica remota;
- **Widget:** le permite seleccionar los widgets que aparecen en la pantalla principal de gestión del dispositivo;
- **Ajustes Menú:** le permite personalizar la visualización de las funciones del menú. Algunas características pueden no estar disponibles debido a la configuración del sistema de calefacción. "PANTALLA DE MENU" en la página 23
- **Ajustes Info:** le permite personalizar la visualización de los valores del sistema del menú de información, "PANTALLA DE INFORMACIÓN" en la página 22
- **Elimina Dispositivo:** permite eliminar el dispositivo actualmente seleccionado;
- **Cambiar clima:** las condiciones meteorológicas que aparecen como widget, se pueden configurar manualmente introduciendo las coordenadas de latitud y longitud deseadas, o utilizando el GPS de su Smartphone;
- **Info:** información técnica sobre el código de producto del panel de control y la versión de firmware del Módulo;
- **Info Wi-Fi:** información sobre la red de Internet a la que está conectado el dispositivo 4HEATModule.





**Estado de funcionamiento:**

muestra el estado en que se encuentra el sistema y cualquier error ocurrido.

**Termostato principal:**



muestra el termostato del sistema.

Mantener presionado el botón  se permite la modificación del termostato.

Use las teclas  o  para desplazarse por la banda de color para cambiar la temperatura.

**Widget:**

mostrar información relacionada con la operación. Se puede decidir qué widgets mostrar en la página principal a través del menú .

 **System ON:** push to turn it off  
 **System OFF:** push to turn it on

**Synchronization:**

 the flashing button indicates that the application and the module are exchanging information. The synchronization result will be displayed in the end.

**Temperatura principal**

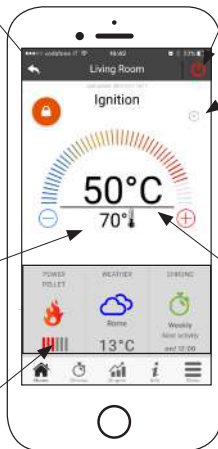

## • FUNCIÓN CHRONO Y 24HEATING

Al acceder al menú Chrono, se puede ajustar la función de gestión del sistema en dos modalidades diferentes.

Presionando  se accede a la modificación de la función deseada.



Dentro de la función **CRONO** se pueden ajustar tres distintas franjas horarias para encender y apagar el sistema de calefacción.

Se puede elegir entre tres tipos de programación:

- Semanal: configuración de lunes a domingo
- Diaria: ajuste de cada día
- Fin de semana: ajuste durante el fin de semana (Sábado y domingo) o durante los días de la semana (de lunes a viernes).

Cada vez que se actualiza esta función es necesario pulsar el botón Guardar que aparece en la parte inferior de la pantalla.

Para restablecer franja horaria, utilice la papelera que aparece con con deslizador táctil a su derecha.

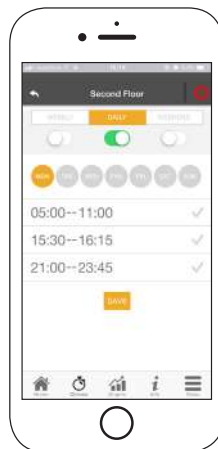



## • FUNCIÓN CHRONO Y 24HEATING

La función **24HEATING** permite, a través de un procedimiento guiado, gestionar la calefacción doméstica, estableciendo tiempos y temperaturas, de acuerdo con las necesidades diarias. Durante el procedimiento guiado se les hacen unas simples preguntas de rutina diaria, a través de las cuales el 24Heating ajusta la programación semana.

Es posible elegir el termostato para las tres franjas disponibles:



**24HEATING** permite administrar las franjas horarias incluso desde la página principal:

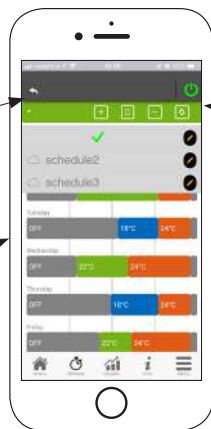

Elección y creación de un programa de calefacción

Franjas horarias creadas por el proceso



Teclas de gestión

## 🕒 • FUNCIÓN CHRONO Y 24HEATING

1. **Gestión del programa 24HEATING:** El menú desplegable en la parte superior izquierda muestra los programas establecidos por el usuario. Seleccione la nube para habilitar el programa. Presione el símbolo  para cambiar los termostatos de cada franja
2. **Agregar franja horaria:** Al seleccionar el botón  se puede desdoblarse un intervalo de tiempo, como se muestra en las imágenes:

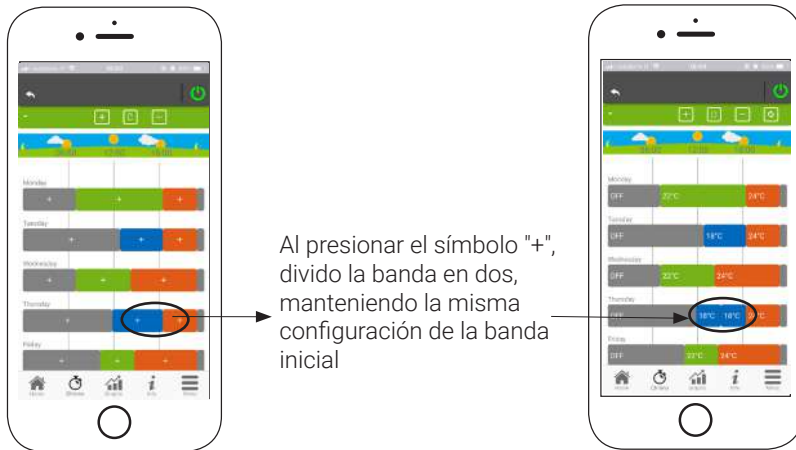

## 🕒 • FUNCIÓN CHRONO Y 24HEATING

3. **Eliminación de la franja horaria:** al seleccionar el botón  e puede eliminar un intervalo de tiempo, como se muestra en las imágenes:



4. **Actualiza los cambios:** A través del botón  el 24Heating se sincroniza con el dispositivo. Asegúrese de presionarlo cada vez que se realice un cambio.

## 🕒 • FUNCIÓN CHRONO E 24HEATING

5. **Copia de una franja horaria:** Al seleccionar el botón  puedo copiar las franjas horarias de un día a otro. Pulse la tecla de confirmación en la parte inferior de la página
6. **Cambio de franja horaria:** Pulsando en una franja horaria se accede al menú de gestión, como se muestra en la imagen

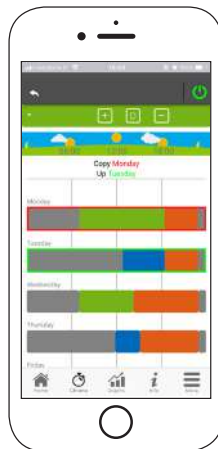

## • VISUALIZACIÓN DE GRÁFICOS

Esta sección muestra los gráficos de los valores registrados en el servidor por el 4HEATModule. Hay dos tipos de vistas disponibles:

1. **Diaria:** los valores visualizados se representan a lo largo del día de funcionamiento del sistema de calefacción. Se pueden visualizar dos franjas horarias: 00:00/12:00 o 12:00/00:00.
2. Además se puede también elegir mostrar los estados de funcionamiento del sistema de calefacción (por ejemplo Apagado, Normal, Bloqueo). Los datos grabados permanecen en la memoria semanalmente;
3. **Período:** representación gráfica de las horas de funcionamiento del sistema sobre base semanal. Los datos grabados permanecen en la memoria anualmente.



## **i** • PANTALLA DE INFORMACIÓN

Esta pantalla muestra todos los valores registrados por la placa de control. Los valores por visualizar se pueden configurar a través del menú ajustes del módulo 4HEAT seleccionado. "SETTING 4HEAT" en la página 14



**i** Además se pueden visualizar los datos de referencia del proveedor del servicio y enviar posibles solicitudes de asistencia por correo electrónico. En el caso de que la App esté personalizada para un cliente específico, será posible introducir sus datos de identificación.

## 4 • PANTALLA DE MENU

En la pantalla Menú, puede acceder a:

- **Gestión de potencia:** en este menú es posible modificar la potencia de combustión y / o la potencia de calefacción;
- **Gestión del termostato:** permite cambiar el termostato principal y otros termostatos si así lo requieren las funciones del sistema de calefacción.





TiEmme elettronica Zona Ind.Le Torre Sapienza snc 06055 Marsciano (PG) - ITALY  
info@tiemmeelettronica.it • www.tiemmeelettronica.it